

INSTRUCTION MANUAL

BK PRECISION 3010

FUNCTION GENERATOR



TEST INSTRUMENT SAFETY

WARNING

Normal use of test equipment exposes you to a certain amount of danger from electrical shock because testing must often be performed where exposed voltage is present. An electrical shock causing 10 milliamps of current to pass through the heart will stop most human heartbeats. Voltage as low as 35 volts dc or ac rms should be considered dangerous and hazardous since it can produce a lethal current under certain conditions. Higher voltages pose an even greater threat because such voltage can more easily produce a lethal current. Your normal work habits should include all accepted practices that will prevent contact with exposed high voltage, and that will steer current away from your heart in case of accidental contact with a high voltage. You will significantly reduce the risk factor if you know and observe the following safety precautions:

Don't expose high voltage needlessly. Remove housings and covers only when necessary. Turn off equipment while making test connections in high-voltage circuits. Discharge high-voltage capacitors after removing power.

2. Use an insulated floor material or a large, insulated floor mat to stand on, and an insulated work surface on which to place equipment; and make certain such surfaces are not damp or wet. Where insulated floor surface is not available, wear heavy gloves.
3. Use the time-proven "one hand in the pocket" technique while handling an instrument probe. Be particularly careful to avoid contacting a nearby metal object that could provide a good ground return path.

Always use an isolation transformer to power transformerless "hot chassis" equipment, where one side of the ac power line is connected directly to the chassis. This includes most recent television sets and audio equipment. Without an isolation transformer, the chassis of such equipment may be floating at line voltage (120 VAC, 60 Hz in USA), depending upon which way the 2-wire ac power plug is inserted. Not only does this present a dangerous shock hazard if the chassis is touched, but damage to test instruments or the equipment under test may result from connecting the ground lead of some test instruments to a "hot" chassis. The ground lead of this function generator and most other test instruments with 3-wire power plugs is at earth ground.

5. On test instruments or any equipment with a 3-wire ac power plug, use only a 3-wire outlet. This is a safety feature to keep the housing or other exposed elements at earth ground.
6. If possible, familiarize yourself with the equipment being tested and the location of its high voltage points. However, remember that high voltage may appear at unexpected points in defective equipment.
7. Also remember that ac line voltage is present on some power input current points such as on-off switches, fuses, power transformers, etc., even when the equipment is turned off.
8. Never work alone. Someone should be nearby to render aid if necessary. Training on CPR (cardio-pulmonary resuscitation) first aid is highly recommended.

INSTRUCTION MANUAL
FOR
MODEL 3010
FUNCTION GENERATOR

BK PRECISION DYNASCAN
CORPORATION

01
02

6460 W. Cortland Street
Chicago, Illinois 60635

TABLE OF CONTENTS

	PAGE
INTRODUCTION	3
SPECIFICATIONS	3
PANEL CONTROLS AND FEATURES	5
OPERATING INSTRUCTIONS	
A. Frequency and Waveform Selection, Manual Operation	8
B. DC Output	9
C. Voltage-Controlled Operation	10
D. TTL Output	12
APPLICATIONS	
A. Amplifier Frequency Response	13
B. Tone Control Test	13
C. Amplifier Overload Characteristic	13
D. Amplifier Performance Evaluation Using Square Waves	16
E. Speaker System Testing	18
F. AM Receiver Alignment	18
G. Using the 3010 As A Bias and Signal Source	20
H. Preset Frequency Selection	21
I. Digital Frequency Selection	22
J. Communications Receiver Alignment	23
K. Additional Applications	23
THEORY OF OPERATION	
General Circuit Description	25
Detailed Circuit Description	27
MAINTENANCE AND CALIBRATION	
Removal of Rear Case	31
Calibration Procedure	32
Line Voltage Conversion	36
WARRANTY SERVICE INSTRUCTIONS	37
ONE-YEAR LIMITED WARRANTY	38

INTRODUCTION

The **B & K-PRECISION** Model 3010 Function Generator is a versatile signal source that can be used in a variety of engineering, industrial, educational and hobbyist applications. The wide frequency range (.1 Hz to 1 MHz) for all functions (sine, square, triangle and TTL output) encompasses subaudible, audio, ultrasonic and RF applications. The continuously variable DC offset control and provision for external VCO control further enhance the versatility of this instrument. The human-engineered case lends itself to bench use as well as easy portability.

SPECIFICATIONS

GENERAL

Basic Outputs	Square, sine, triangle, DC and TTL Square Wave (separate output jack).
Frequency Range	0.1 Hz to 1 MHz in six ranges.
External Frequency Control	VCO; greater than 100:1 on any frequency range (linear). With FREQUENCY dial set at .1, a 0-to-5.5 V ramp input will produce a 100:1 frequency change. Frequency increases with positive voltage.
Maximum Input	± 20 V peak.
Input Impedance	1000 ohms, nominal.





SPECIFICATIONS (All specifications apply with dial scale between 1 and 10)

Dial Accuracy	5% of full scale to 500 kHz, 8% of full scale from 500 kHz to 1 MHz (includes dial scale accuracy and range-to-range accuracy). Unit calibrated at full scale.
Dial Range	Greater than 100:1.
Output Impedance	600 Ω , $\pm 5\%$.
Output Amplitude	20 V p-p open circuit; 10 V p-p into 600 Ω .
Amplitude Control	Continuously variable, greater than 30 dB range.

DC Offset	Continuously variable, ± 10 V, open circuit; ± 5 V, into 600Ω . Max. $V_{AC} + V_{DC}$ offset without clipping, ± 10 V open circuit; ± 5 V into 600Ω .
Sine Wave Distortion	Less than 1%, 1 Hz to 100 kHz; harmonics more than 30 dB down from fundamental, 100 KHz to 1 MHz.
Square Wave Non-Symmetry	Less than 1%, to 100 KHz.
Triangle Wave Non-Linearity	Less than 1%, to 100 KHz.
Square Wave Rise/Fall Time	Less than 100 nSEC at maximum output amplitude.
Sine Wave Amplitude Flatness	± 3 dB to 1 MHz at maximum output amplitude.
TTL Square Wave Response	Less than 25 nSEC rise/fall time. Fixed TTL level: LO less than .4 V; HI greater than 2.4 V. Will drive 20 TTL loads.
Short-Term Stability	.05%
Power Requirements	105 to 130 VAC, 60 Hz. 8 watts max. (105-130/210-260 VAC, 50/60 Hz export version available)
Dimensions (HWD)	3.2 x 11.3 x 7.7" (8.13 x 28.70 x 19.56 cm.)
Weight	2 lbs., 9 oz. (1.16 Kg.) without line cord. 2 lbs., 14 oz. (1.31 Kg.) with line cord.
Handle	Four positions: integral part of case.

PANEL CONTROLS AND FEATURES

(See Fig. 1)

1. **POWER on-off switch.** Depressing this button turns the 3010 on. To turn off, push again and release.
2. **RANGE selectors.** Decade frequency type. Multiplying the range selected times the FREQUENCY dial (6) indication gives the *output frequency*, which applies for all functions. For example, if the 100 K RANGE button is depressed and the FREQUENCY dial is at 10, the output frequency is 1 MHz.
3. **FUNCTION selectors.** Select square () , sine () , or triangle () output waveform which appears at 600Ω OUTPUT jack (9).
4. **AMPLITUDE control.** Controls the amplitude of the output signal, which appears at 600Ω jack (9). This control does not apply to the DC OFFSET voltage or to the TTL output.
5. **DC OFFSET control.** Adds positive or negative DC component to the signal appearing at 600Ω OUTPUT jack (9). Continuously variable for ±5 V (600 ohms) or ±10 V (open circuit). The DC component added by this control is dependent of the adjustment of AMPLITUDE control (4).
6. **FREQUENCY dial.** Multiplying the setting of this dial times the frequency of the RANGE switch (2) selected gives the output frequency of the waveforms at the 600Ω OUTPUT jack (9) and TTL jack (7).
7. **TTL jack.** A TTL square wave is available at this jack. The frequency is determined by the RANGE selected and the setting of the FREQUENCY dial. This output is independent of the AMPLITUDE and DC OFFSET controls.
8.  (Ground) jack. Common reference for the TTL and 600Ω OUTPUT signals.
9. **600Ω OUTPUT jack.** Waveforms selected by FUNCTION switches as well as the superimposed DC OFFSET voltage are available at this jack.
10. **HANDLE.** Multiple-position design permits use as a tilt stand or carrying handle.

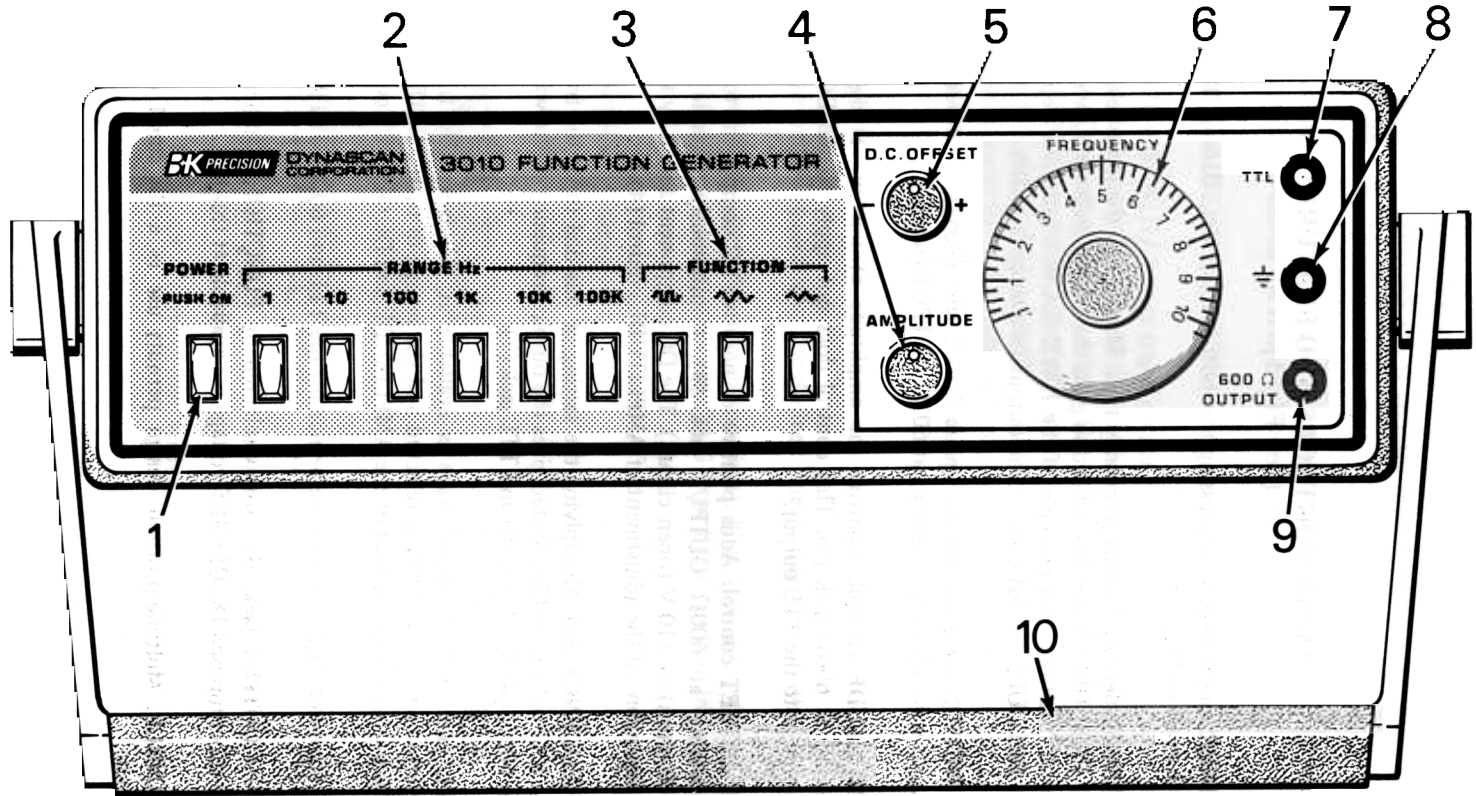

Fig. 1. Front panel controls and features.

11. **VCO INPUT jack (rear panel).** An external voltage input will vary the output frequency. The change in frequency is directly proportional to input voltage; therefore, the rate of change of frequency is proportional to that of the input voltage.
12. **LINE CORD RECEPTACLE (rear panel).** This receptacle accepts the detachable line cord. (Fixed power cord on 105-130/210-260 VAC, 50/60 Hz export version.)

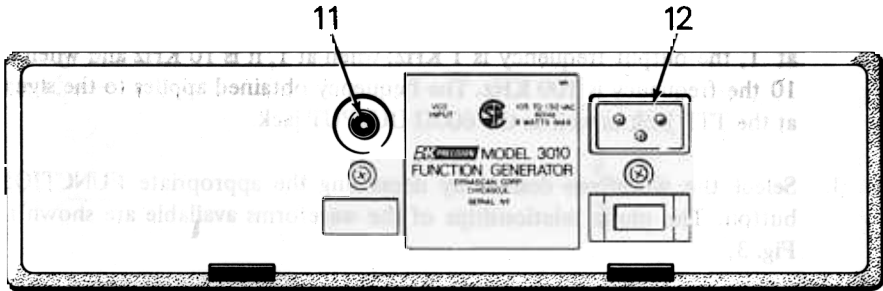

Fig. 2. Rear panel.

OPERATING INSTRUCTIONS

A. FREQUENCY AND WAVEFORM SELECTION, MANUAL OPERATION

- With the unit plugged into a power source, depress the POWER button (1).
2. Select the frequency range desired by depressing the appropriate RANGE switch. The frequency range obtained as the FREQUENCY dial (6) is varied will be from one-tenth the indicated RANGE value to 10 times this value. For example, select the 10 K range. When the FREQUENCY dial is at .1, the output frequency is 1 KHz; when at 1, it is 10 KHz and when at 10 the frequency is 100 KHz. The frequency obtained applies to the signal at the TTL jack as well as the 600 Ω OUTPUT jack.
 3. Select the waveform desired by depressing the appropriate FUNCTION button. The phase relationships of the waveforms available are shown in Fig. 3.
 4. The amplitude of the selected output signal at the 600 Ω OUTPUT jack is adjusted by AMPLITUDE control (4). The TTL output is not affected by the AMPLITUDE control.
 5. A DC component can be added to the signal at the 600 Ω OUTPUT jack by use of the DC OFFSET control. The DC component introduced is independent of the AMPLITUDE control and does not apply to the TTL output. The level of DC can be varied ± 10 volts open circuited or ± 5 volts across 600 ohms.

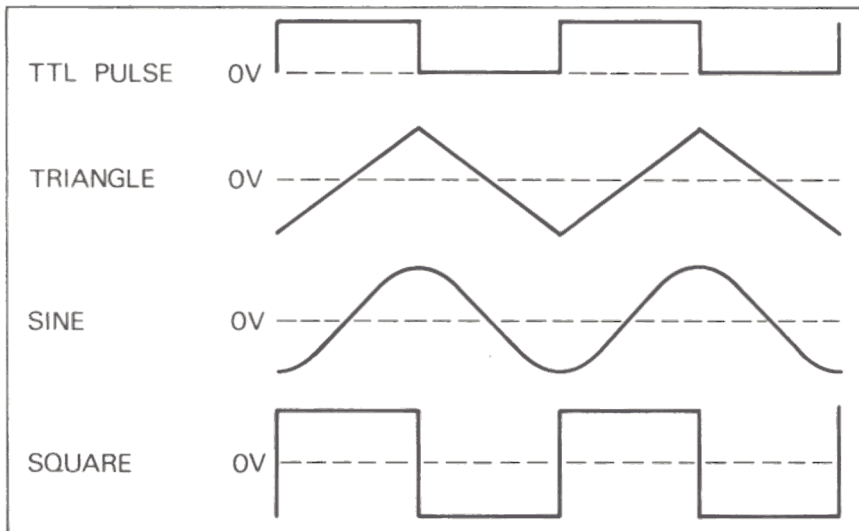

Fig. 3. Output waveform and phase relationships.

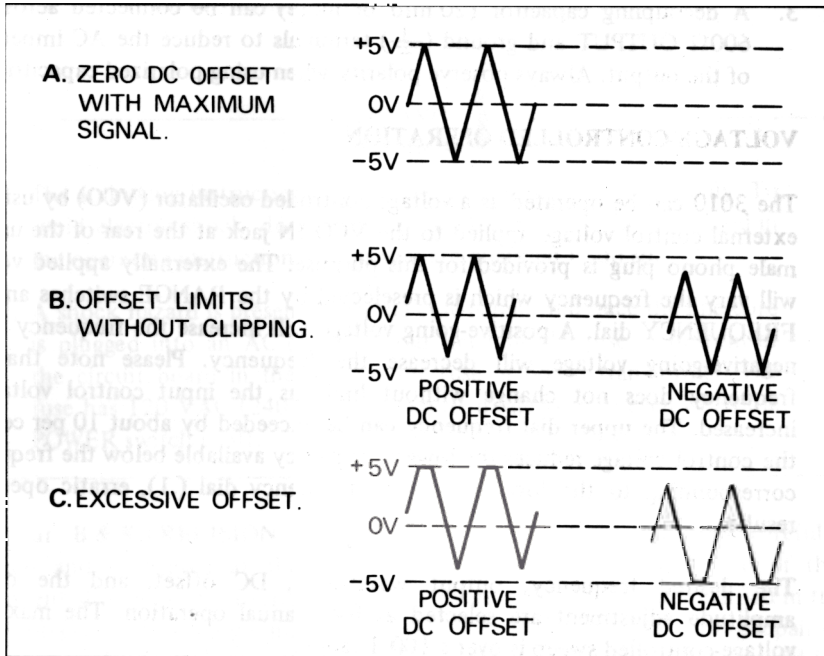

Fig. 4. Use of DC OFFSET control.

6. Remember that the output signal swing of the generator is limited to ± 10 volts (open circuit) or ± 5 volts into 600 ohms. This applies to the combined signal and DC offset. Clipping occurs slightly above these levels. Fig. 4 illustrates the various operating conditions encountered, when using the DC offset. If the desired output signal is large or if a large DC offset is used, an oscilloscope should be used to make sure that the desired combination is obtained without undesirable clipping.
7. When using the higher output frequencies and when using the square wave and TTL outputs, terminate the cable in 600 ohms to minimize ringing. Keep the cables as short as possible.

B. DC OUTPUT

The DC OFFSET feature can be used to convert the Model 3010 to a bipolar DC power supply with an internal impedance of about 600 ohms.

Depress the FUNCTION switches slightly so that all switches are released (all buttons out). This removes all signal components from the output.

2. The output now consists of a DC voltage which can be varied continuously from -10 volts to +10 volts (open circuit) by use of the DC OFFSET control.

A decoupling capacitor (20 mfd or more) can be connected across the 600Ω OUTPUT and ground ($\frac{\perp}{\text{---}}$) terminals to reduce the AC impedance of the output. Always observe polarity when using polarized capacitors.

C. VOLTAGE-CONTROLLED OPERATION

The 3010 can be operated as a voltage-controlled oscillator (VCO) by using an external control voltage applied to the VCO IN jack at the rear of the unit. A male phono plug is provided for this purpose. The externally applied voltage will vary the frequency which is preselected by the RANGE switches and the FREQUENCY dial. A positive-going voltage will increase the frequency and a negative-going voltage will decrease the frequency. Please note that the frequency does not change without limit as the input control voltage is increased. The upper dial frequency can be exceeded by about 10 per cent. If the control voltage reduces the lowest frequency available below the frequency corresponding to the low end of the frequency dial (.1), erratic operation results.

The desired frequency, output waveforms, DC offset, and the output amplitude adjustment are selected as for manual operation. The maximum voltage-controlled sweep is over a 100:1 range.

SWEEP FREQUENCY OPERATION

- a. Select frequency range and function.
- b. Set DC offset, if required.
- c. Set amplitude to desired level.
- d. To obtain maximum sweep, set the FREQUENCY dial to either extreme. For this example, set at low end (.1 on FREQUENCY dial).
- e. Connect a positive-going voltage to the VCO IN jack. A 0 to +5.5 volt ramp will provide a frequency increase corresponding to a FREQUENCY dial setting of 10. This is a 100:1 ratio. The frequency varies in direct proportion to the applied input voltage.

2. FREQUENCY MODULATION

If an alternating voltage with no DC component is applied to the VCO IN jack, the preset frequency will vary above and below the frequency that was preset by the RANGE switch and FREQUENCY dial. The DC component of such an input signal can be removed by transformer or capacitive coupling.

- a. Select frequency and function.
- b. Set DC offset, if required.
- c. Set amplitude to desired level.
- d. Adjust the VCO IN voltage to provide the desired frequency modulation.
- e. The approximate frequency deviation obtained for a given VCO signal can be determined as follows:
 - (1) .055 volt will produce a change in frequency equal to one per cent of the highest frequency obtainable on a given range. For example, if the 1 K RANGE is selected and the FREQUENCY dial is at 10, the output frequency is 10 KHz. One per cent of 10 KHz is 100 Hz. Therefore, for each .055 volt change in the VCO voltage, a 100 Hz change in frequency is produced with the 1 K RANGE selected, regardless of FREQUENCY dial setting.
 - (2) As an example, assume the RANGE switch and FREQUENCY dial are set for 5 KHz output. If an alternating signal having an amplitude of $\pm .55$ volt is applied to the VCO IN jack, a frequency swing of $\pm (\frac{.55}{.055}) 100 = \pm 1$ KHz is obtained. The table below indicates the frequency change per .055 volt input to the VCO IN jack for each range.

Range, Hz	Min. Frequency, Hz (Dial at .1)	Max. Frequency, Hz (Dial at 10)	1% Frequency Change, Hz (For .055 V input)
1	.1	10	.1
10	1	100	1
100	10	1 K	10
1K	100	10 K	100
10 K	1 K	100 K	1 K
100 K	10 K	1 M	10 K

D. TTL OUTPUT

This is a fast rise time square wave output, available at the front panel. Because of the fast transition times of this output, cable termination should be provided to minimize ringing. The output is always positive with respect to ground. This signal can be used as an external sync pulse for oscilloscopes when using the other generator outputs. It also can be used as a variable frequency signal source for exercising logic circuits.

1. Select desired frequency (repetition rate).
2. Connect to TTL output.
3. The AMPLITUDE and DC OFFSET controls have no effect on the TTL output signal.

APPLICATIONS

A. AMPLIFIER FREQUENCY RESPONSE (See Fig. 5)

1. Interconnect equipment as indicated Fig. 5A. This use of either the oscilloscope or the AC voltmeter to measure output voltage is adequate. The advantage of the oscilloscope is that waveform distortion can be simultaneously monitored, particularly if a power response curve is being run. The AC voltmeter, provided with decibel scales, is convenient for converting the observed output variations into standard units of measurement (dB). The amplifier under test may be anything from a single stage transistor amplifier to a high fidelity component type. The dual trace oscilloscope is convenient for this application because the input to the amplifier as well as the output can be monitored simultaneously.

Vary the frequency of the 3010 as required, maintaining a constant amplitude as observed on the oscilloscope. The amplifier input and output waveforms can be monitored simultaneously as indicated in Fig. 5b. Using two centimeters for amplitude references provides a convenient method of determining percent of change in amplitude.

3. The results of response tests can be plotted on semi-log paper as indicated in Fig. 6.

B. TONE CONTROL TEST

If the amplifier under test is provided with base and treble controls, the effects of these controls on overall response can be determined by running consecutive response curves with the controls at both extremes of adjustment. The results can be plotted on semi-log graph paper, as indicated in Fig. 7.

C. AMPLIFIER OVERLOAD CHARACTERISTIC

1. The overload point for some amplifiers is difficult to determine exactly because of the gradual overload characteristic. The exact point of which signal compression begins is difficult to determine using sine-wave input. The triangle wave form is ideal for this type of test because any departure from absolute linearity is readily detectable.
2. Using the test set-up of Fig. 5A and using the triangle output, the peak overload condition for an amplifier can be readily determined. This overload condition is shown in Fig. 8.

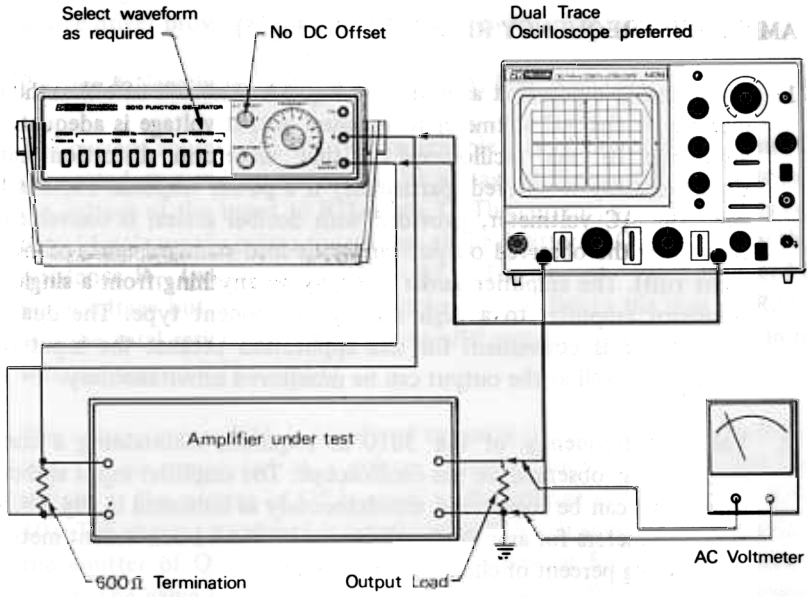

A. TEST SET-UP.

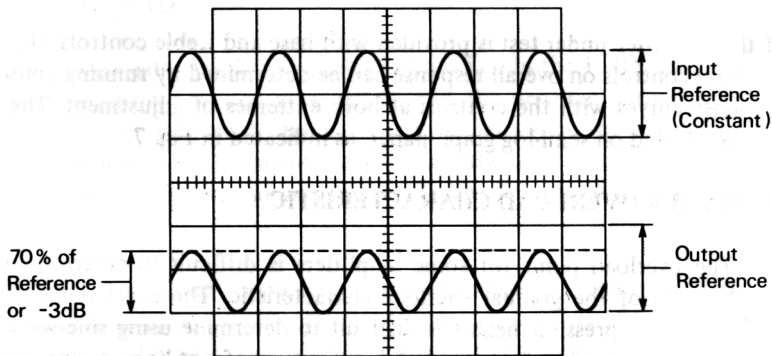

B. WAVE SHAPE AND AMPLITUDE.

Fig. 5. Amplifier frequency response, manual frequency change.

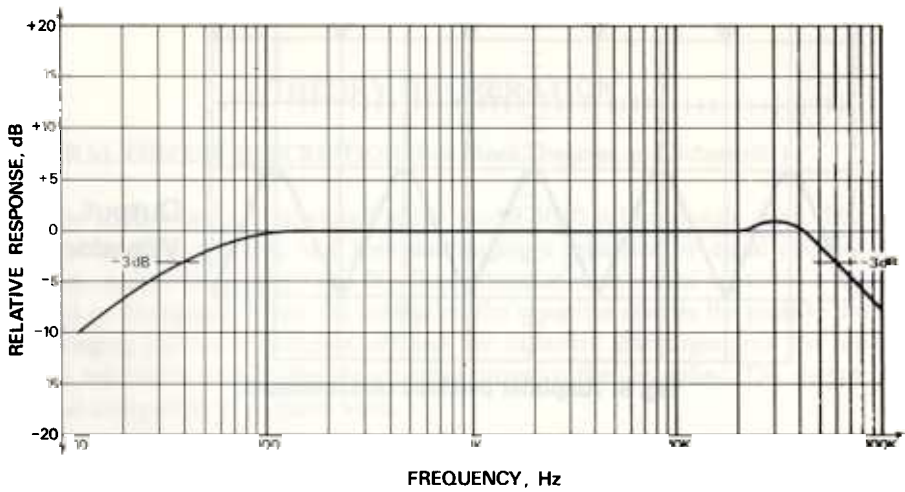

Fig. 6. Plot of amplifier frequency response.

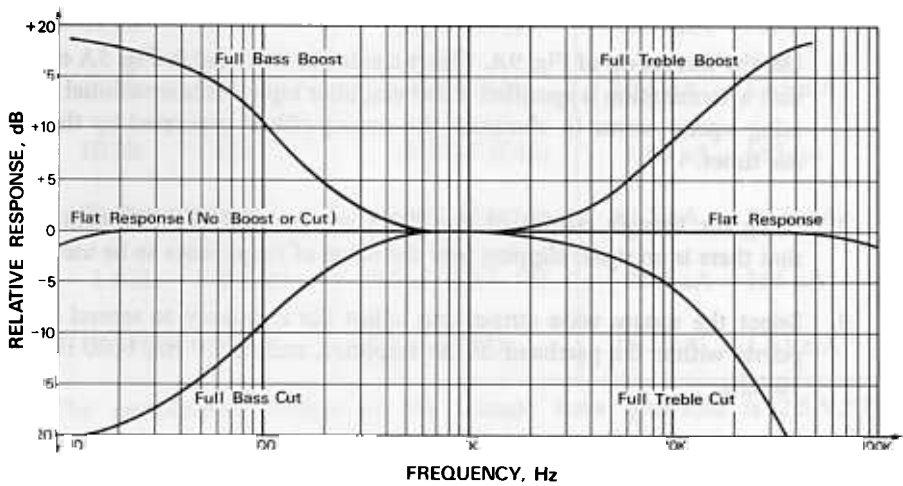

Fig. 7. Tone control effectiveness.

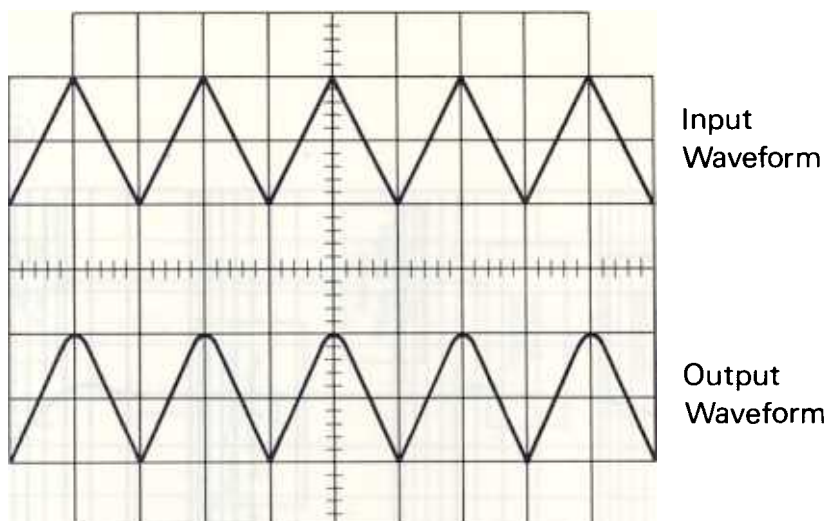

Fig. 8. Amplifier overload characteristics.

D. AMPLIFIER PERFORMANCE EVALUATION USING SQUARE WAVES

The standard sine-wave frequency response curves, such as those obtained in Par. A, do not give a full evaluation of the amplifier transient response. The square wave, because of the high harmonic content, yields much information regarding amplifier performance, when used in conjunction with an oscilloscope.

Use the test set-up of Fig. 9A. This is similar to that used in Fig. 5A except that a termination is specified at the amplifier input. This is essential when using square waves to eliminate the ringing effects generated by the fast rise times.

2. Using the triangle output of the 3010, set the **AMPLITUDE** control so that there is no signal clipping over the range of frequencies to be used.

Select the square wave output and adjust the frequency to several check points within the passband of the amplifier, such as 20 Hz, 1000 Hz and 10 KHz.

4. At each frequency check point the wave form obtained at the amplifier output provides information regarding amplifier performance with respect to the frequency of the square wave input. Fig. 9B indicates the possible wave forms obtained at the amplifier output and the causes.

Square wave evaluation is not practical for narrow band amplifiers. The restricted band width of the amplifier cannot reproduce all frequency

components of the square wave in the proper phase and amplitude relationships.

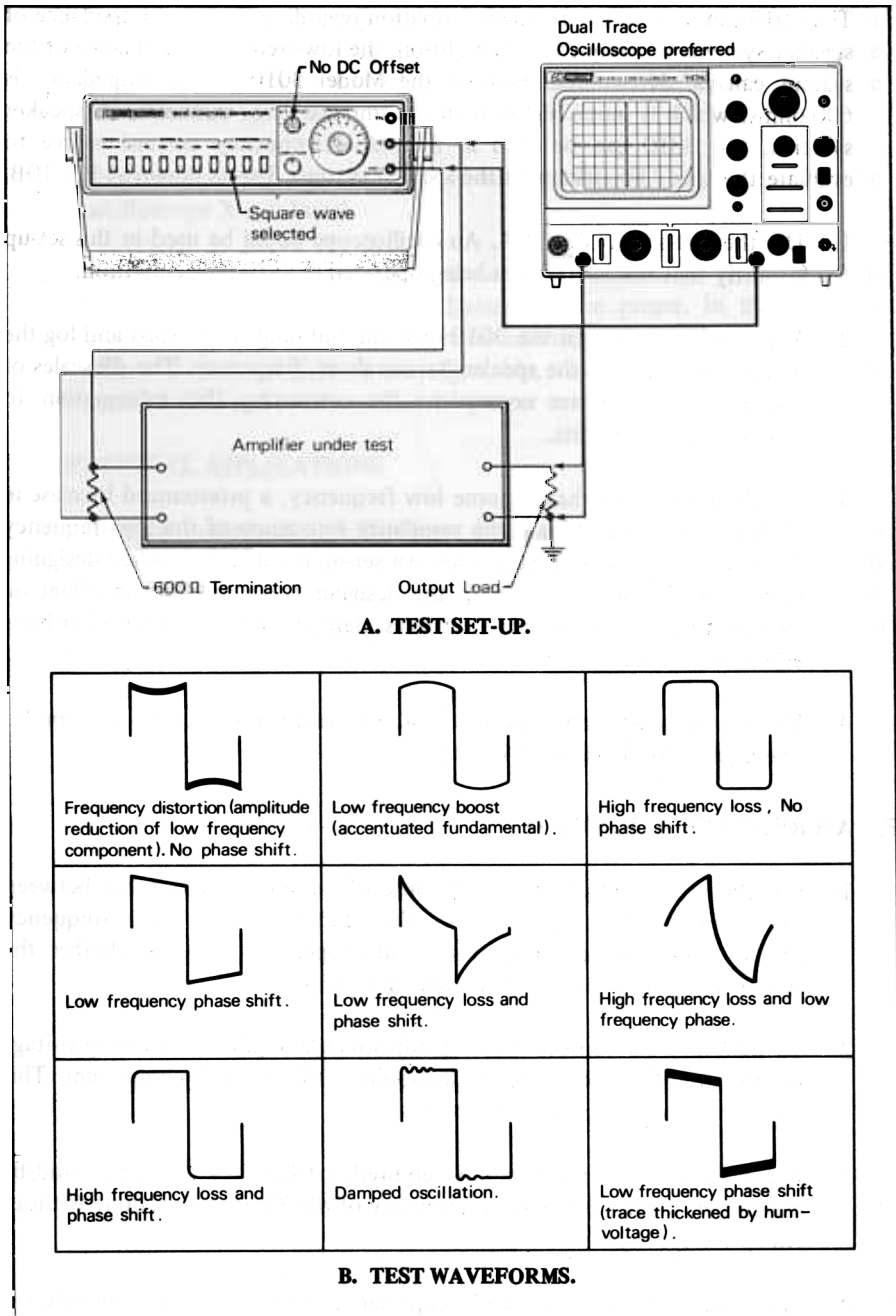

Fig. 9. Amplifier performance evaluation, using square waves.

E. SPEAKER SYSTEM TESTING

The 3010 can be used to provide information regarding the input impedance of speaker systems vs. frequency. In addition, the low-frequency resonance of the system can be determined. Because the Model 3010 output impedance is 600 ohms, which is much higher than the impedance of conventional speaker systems, the 3010 can be used as a variable frequency current source to evaluate the input impedance of the speaker system. This is shown in Fig. 10B.

1. Use the test set-up Fig. 10A. An oscilloscope could be used in this set-up to verify that the 3010 is not being operated in a clipping condition.
2. Vary the frequency of the 3010 over the full range of interest and log the voltage measured at the speaker terminals vs. frequency. The dB scales of the AC voltmeter are convenient for converting this information to standard response units.
3. It will be observed that at some low frequency, a pronounced increase in voltage will occur. This is the resonance frequency of the low-frequency driver in the speaker system. This test set-up is convenient when designing speaker enclosures. It can help the designer to determine the effect on system resonance of varying port sizes, damping materials and other basic enclosure factors.
4. The measurements obtained in the above tests can be plotted on semi-log graph paper as indicated in Fig. 10C.

F. AM RECEIVER ALIGNMENT

1. Use the test set-up of Fig. 11. Because of the linear relationship between sweep voltage and frequency of the Model 3010, a linear frequency presentation is obtained on the oscilloscope, regardless of whether the sweep voltage is a triangle, sine wave or a ramp.
2. To minimize the number of set-up adjustments required, the sweep voltage to the VCO IN jack of the 3010 should *not* have a DC component. This can be removed by capacitor coupling.
3. If a precise center frequency is required, a frequency counter should be used when setting the output frequency of the 3010. This is done without sweep voltage input.
4. The sweep voltage to the oscilloscope can be supplied either to an external horizontal input jack or, if the oscilloscope has front panel X-Y capability, it can be applied to one of the two vertical input jacks.

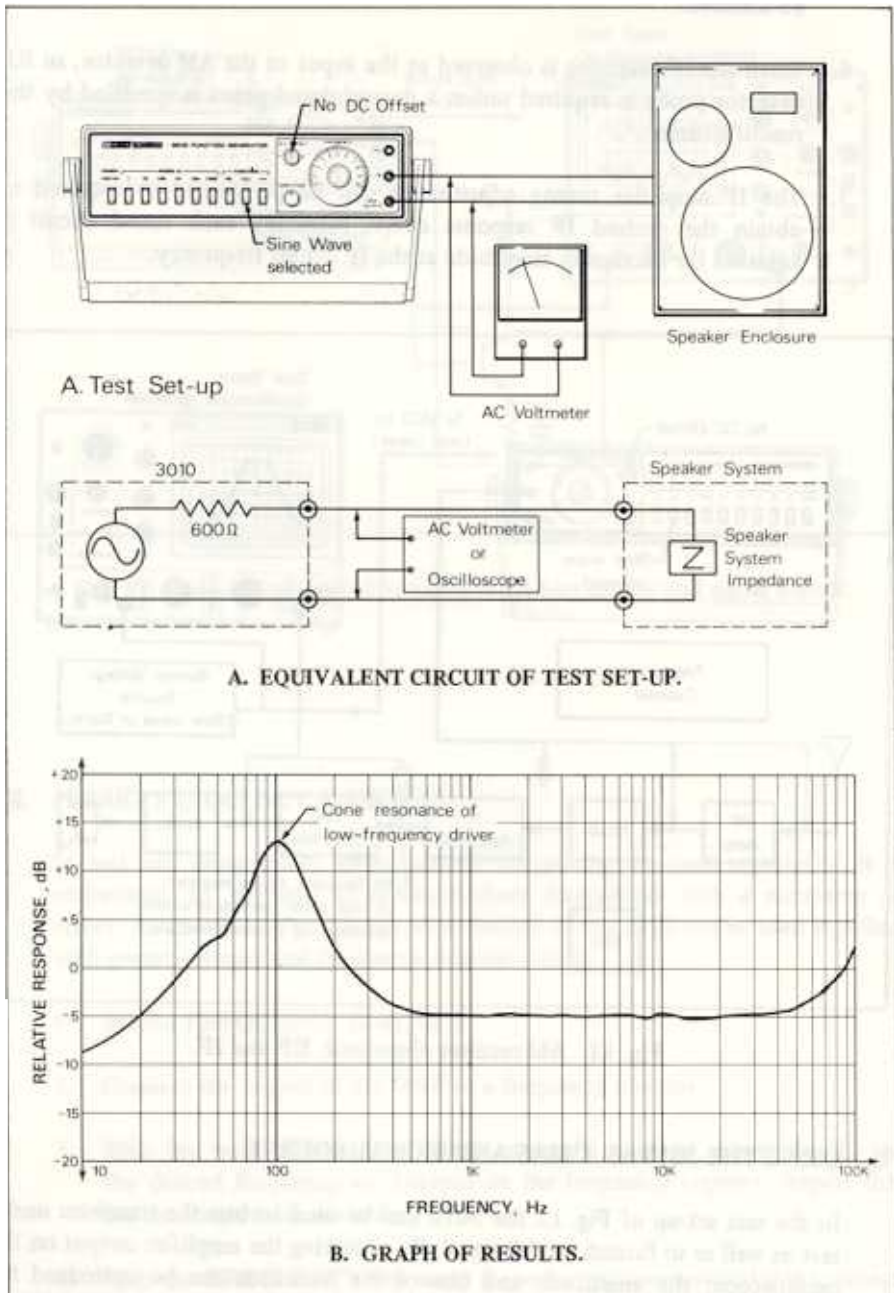

Fig. 10. Speaker system tests.

5. Because of the wide frequency range of the 3010, the signal can be injected either at the mixer (455 KHz) or at the antenna (1 MHz). When injecting the 455 KHz signal at the mixer input, the local oscillator must be disabled.
6. When the IF response is observed at the input to the AM detector, an RF detector probe is required unless a demodulated point is specified by the manufacturer.
7. The IF amplifier tuning adjustments can be performed as required to obtain the desired IF response curve. Normally each tuned circuit is adjusted for maximum amplitude at the IF center frequency.

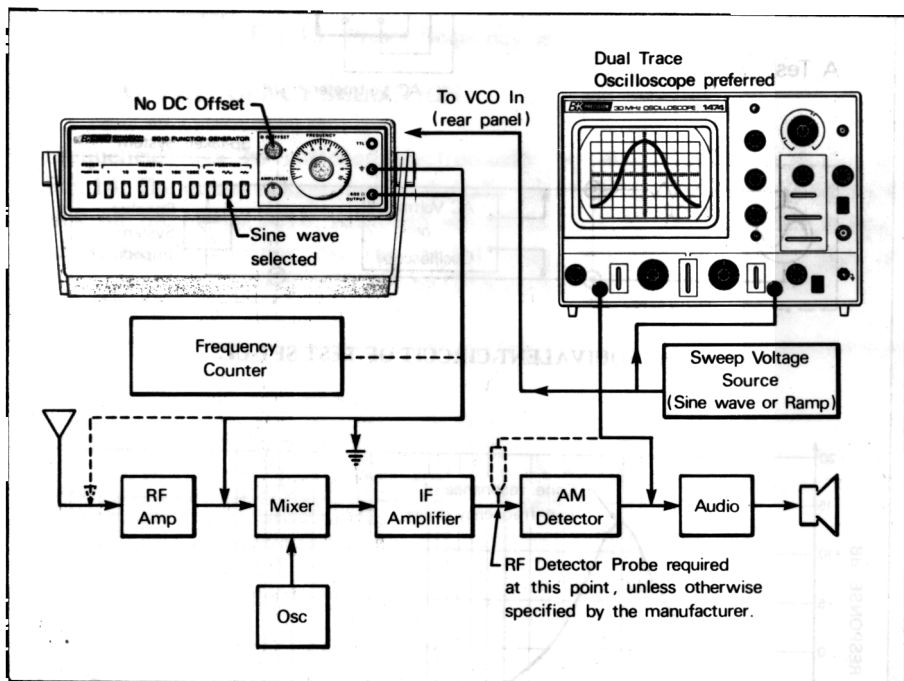

Fig. 11. AM receiver alignment, RF and IF.

G. USING THE 3010 AS A BIAS AND SIGNAL SOURCE

In the test set-up of Fig. 12 the 3010 can be used to bias the transistor under test as well as to furnish an AC signal. By observing the amplifier output on the oscilloscope, the amplitude and bias of the transistor can be optimized for maximum undistorted output. By use of the DC OFFSET control, the effects of various types of bias (class A, B, and C) can be determined.

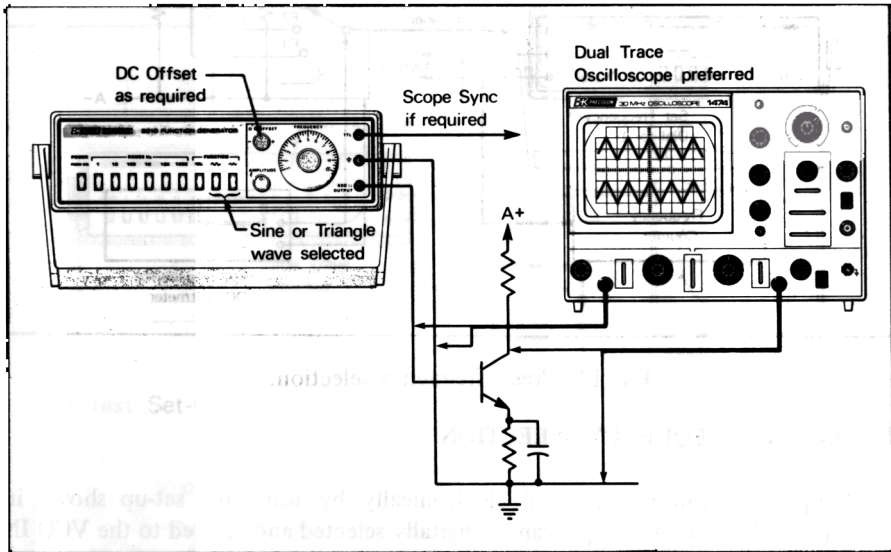

Fig. 12. Use of Model 3010 as a combined bias supply and signal source.

H. PRESET FREQUENCY SELECTION

In test and design work where several frequencies are used repeatedly, it is convenient to be able to preselect these frequencies with a minimum of effort. As shown in Fig. 13, the VCO feature of the 3010 can be used together with preset voltages and frequency selector switch.

1. Set the **FREQUENCY DIAL** to .1.
2. Connect the output of the 3010 to a frequency counter.
3. With the frequency selector switch in the F1 position, adjust the R1 for the desired frequency as observed on the frequency counter. Repeat this for the frequencies desired.
4. With the **FREQUENCY** dial set at .1, and a maximum available A+ voltage of about 6 volts, frequencies encompassing a 100:1 range can be obtained by this method on each frequency range.

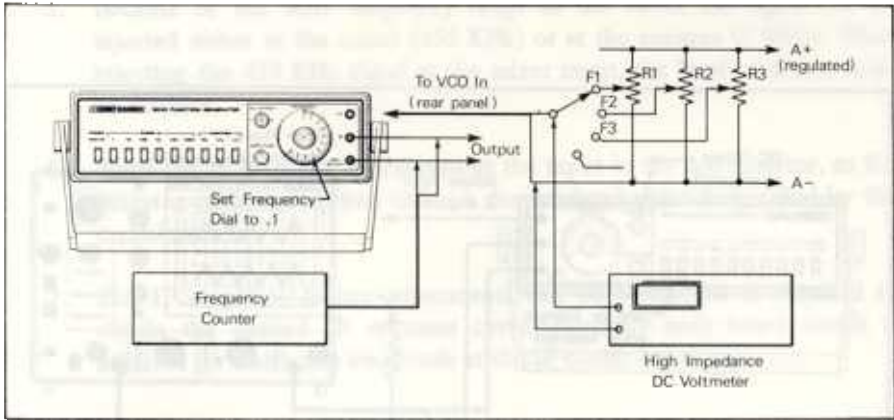

Fig. 13. Preset frequency selection.

I. DIGITAL FREQUENCY SELECTION

Frequencies can be switched electronically by using the set-up shown in Fig. 14. The preset voltages can be digitally selected and applied to the VCO IN jack on the Model 3010. Although provisions for two frequencies are shown, additional frequencies can be added using redundant circuits. This is convenient in frequency shift keying (FSK) systems.

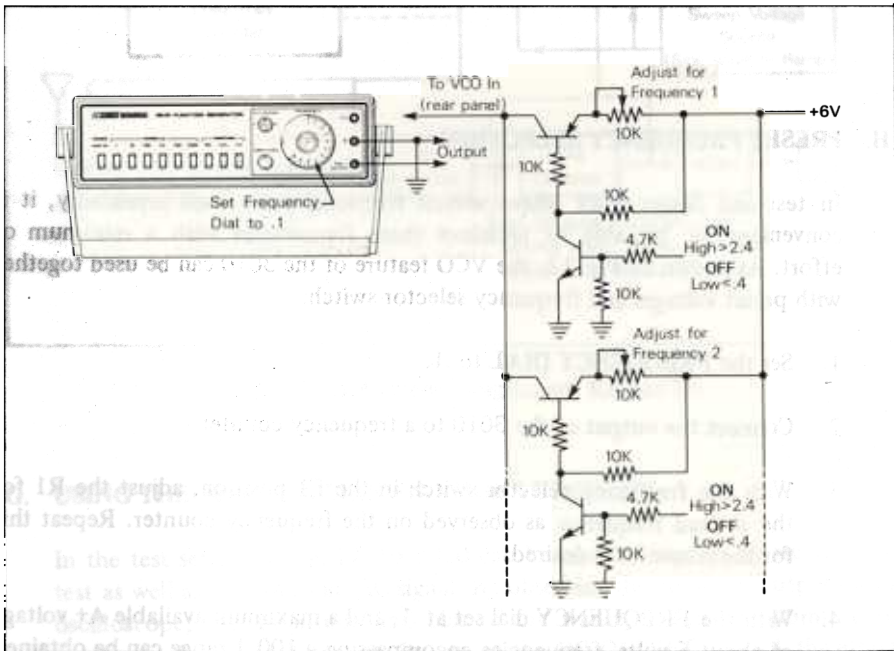

Fig. 14. Digitally programmed frequency selection

J. COMMUNICATIONS RECEIVER ALIGNMENT

The test set-up of Fig. 15 can be used for alignment of communication receiver IF's and discriminators using the 455 KHz IF frequency. For accurate frequency adjustments, a 455 KHz crystal control marker source should be used.

The sweep voltage source is applied to the 3010 VCO IN jack and to the oscilloscope X-axis input.

2. the IF response curve is indicated. In some receivers the IF selectivity is "packaged" which means all adjustments are preset. In this case the receiver alignment can only be evaluated and verified without adjustment. Where the tuned circuits are adjustable, the manufacturer's procedure must be followed to insure that the proper overall response is obtained.

K. ADDITIONAL APPLICATIONS

The triangle output of the 3010 can be used at its lowest frequencies to simulate a slowly varying DC source. This can be used to check threshold levels of TTL and CMOS logic as well as voltage comparators. Chart recorders can be checked by this method. Analog meter movements can be exercised from zero to full scale to observe defects, such as sticky meter movements.

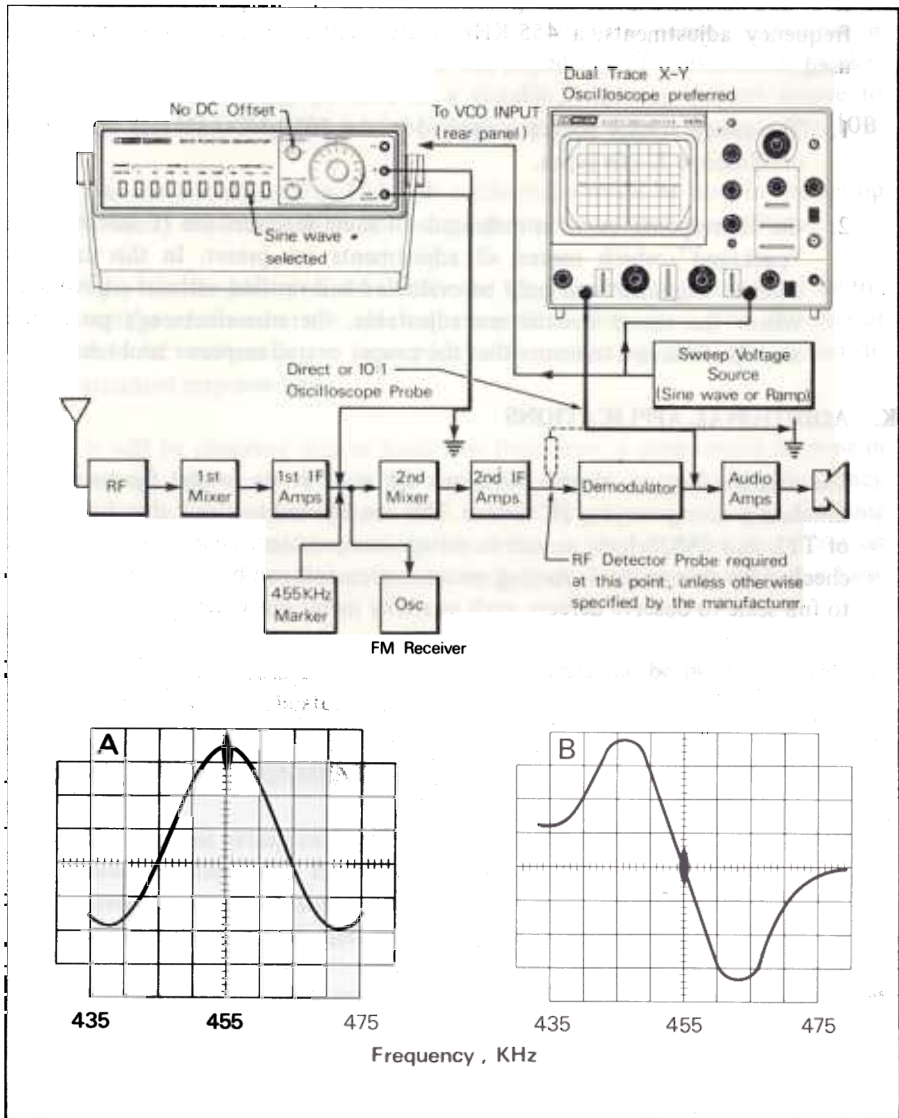

Fig. 15. Alignment of communications IF's and discriminators.

THEORY OF OPERATION

GENERAL CIRCUIT DESCRIPTION (See Block Diagram and Schematic)

The basic waveform generated in the Model 3010 is the triangle wave. This is accomplished by charging and then discharging a capacitor by equal magnitude currents. A dual comparator and flip flop determine whether the capacitor is being charged or discharged. When the voltage on the capacitor reaches the positive limit, the charging current is switched off and the capacitor discharges until the lower limit is reached at which time the charging current is then reapplied. The output of the dual comparator is a square wave.

To produce a sine wave, the triangle wave is shaped by a special amplifier. Range switching is accomplished by changing the magnitude of the current sources and the timing capacitor. Dial frequency tuning is done by changing the magnitude of the current sources. A frequency change of over a 100:1 is possible with the frequency dial. Below is a table of the capacitors and currents used.

RANGE (100:1)	CAPACITOR	CURRENT
.1 Hz – 10 Hz	3.3 μ F (C15)	1.65 μ A – 165 μ A
1 Hz – 100 Hz	3.3 μ F (C15)	16.5 μ A – 1.65 mA
10 Hz – 1 KHz	.033 μ F (C16)	1.65 μ A – 165 μ A
100 Hz – 10 KHz	.033 μ F (C16)	16.5 μ A – 1.65 mA
1 KHz – 100 KHz	325 pF (C17, 18)	1.65 μ A – 165 μ A
10 KHz – 1 MHz	300 pF (C18)	16.5 μ A – 1.65 mA

The peak-to-peak voltage of the triangle wave generated is 2.5 V. The frequency of operation is determined by the currents, the capacitor value and the peak-to-peak voltage of the triangle wave.

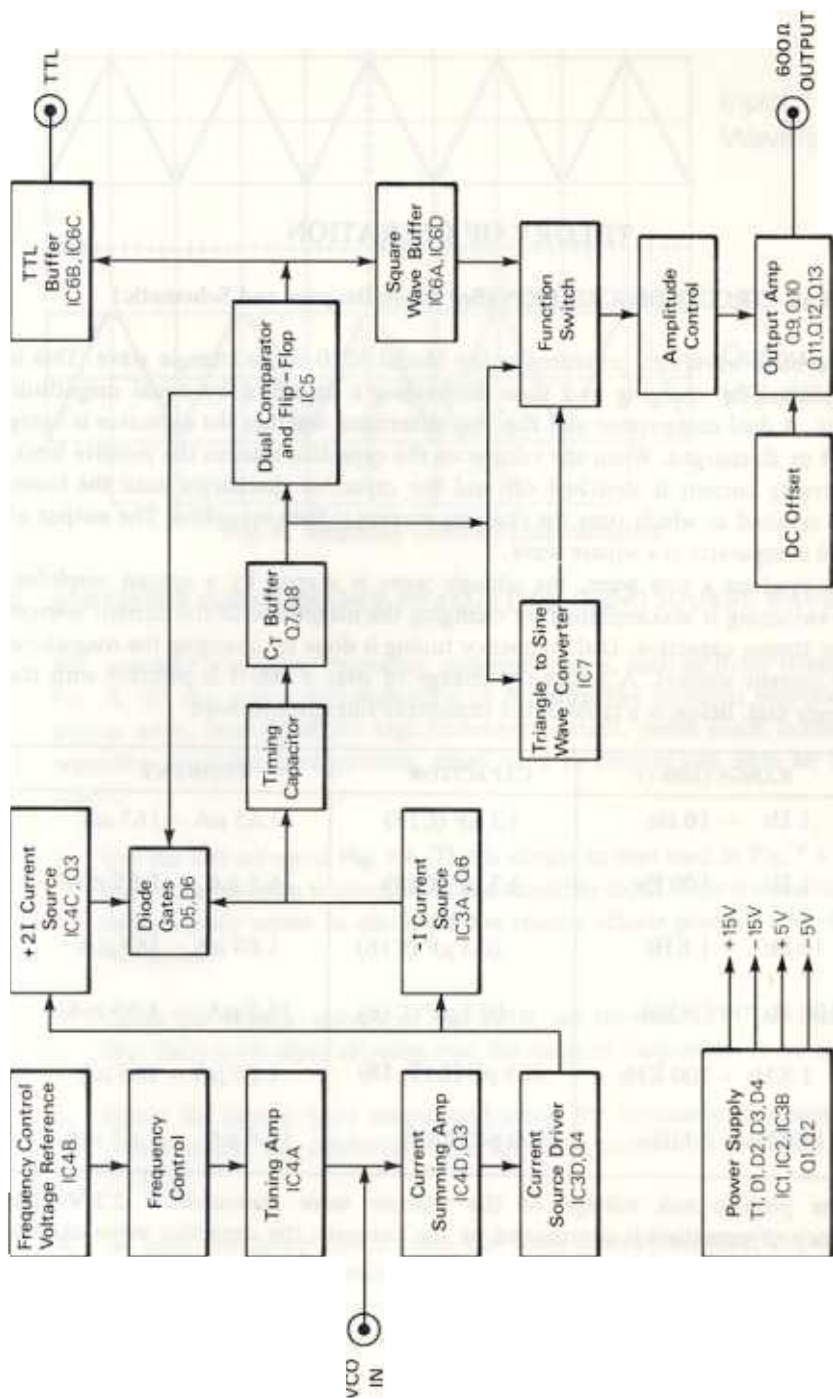

Fig. 16. Model 3010 block diagram.

$$f = \frac{1}{2T} \text{ and } T = \frac{(C)(V_{PP})}{I}; \text{ therefore,}$$

$$f = \frac{1}{(2)(C)(V_{PP})}$$

Thus for $I = 1.65 \text{ mA}$, $C = 3.3 \mu\text{F}$ and $V_{PP} = 2.5 \text{ V}$

$$f = \frac{1.65 \times 10^{-3}}{(2)(3.3 \times 10^{-6})(2.5)}$$

$$f = 100 \text{ Hz}$$

DETAILED CIRCUIT DESCRIPTION

A. Frequency Control Voltage Reference (IC4B)

The Frequency Control Voltage Reference is composed of three trimpots (R11, 12, 13), two resistors and IC4B, which divide the +15 volts supply and provide a reference voltage of approximately +12 volts to the Frequency Control Potentiometer. Each trimpot is adjusted to compensate for the tolerance variations of the timing capacitors.

B. Tuning Amplifier (IC4A)

The tuning amplifier is provided to buffer the output of the Frequency Control Pot. This assures that this voltage will be as linear as the frequency pot R101 itself. If not, R17 would be in parallel with frequency pot R101 and the action of the frequency pot would be non-linear.

C. Current Summing Amplifier (IC4D, Q3)

The current Summing Amplifier sums the current from the tuning amp and the VCO input. The current from the tuning amp is simply the voltage at its output divided by the value of R17 (2K Ω). The current from the VCO input is normally zero. When a voltage is applied, the current into the summer is the voltage divided by R18 (1K Ω). For a 100:1 sweep, the voltage has to be approximately +5.5V. The output current (collector of Q3) creates a voltage across R19 (1K) that tracks the voltage of the tuning amplifier by a factor of $-\frac{1}{2}$.

D. Current Source Driver (IC3D, Q4)

IC3D is an operational amplifier and Q4 is an emitter follower used in

conjunction with the operational amplifier. IC3D and Q4 are connected as a voltage follower with a closed loop gain of +1. The voltage of the emitter of Q4 follows the input voltage of pin 12. The voltage at the collector of Q4 tracks the voltage at the emitter but is of opposite polarity. In this way the current source driver provides both current sources with equal voltages.

E. Positive & Negative Current Sources (IC3A, IC4C, Q5, Q6)

The current sources provide two switchable sets of currents. IC3A and Q6 are connected as a voltage follower. The voltage at the emitter of Q6 is equal to the voltage at the input to IC3A (pin 3). The current, produced, $-I$, is equal to the -15 volt supply minus the voltage at the emitter of Q6, divided by the total resistance R_{T1} (which equals $R22 + R23$). The current $-10I$ is produced by the same voltage but $R24$ has been switched in parallel to the sum of $R22 + R23$ and the total resistance is now the parallel combination R_{T10} ($R24$ in parallel with the sum of $R22 + R23$).

The voltage across $R21$ is equal and opposite to the voltage across $R20$. IC4C and Q5 are connected as a voltage follower similar to IC3A and Q6. The voltage at the emitter of Q5 is equal to the voltage at the input to IC4C (pin 10). The current produced is equal to the $+15$ volt supply minus the voltage at the emitter of Q5 divided by the total resistance R_{T2} (which equals $R25 + R26$). The value of R_{T2} is half the value of R_{T1} , therefore the current is $2I$. Similarly, when the combination, $R27 + R28$, is switched in parallel to the combination $R25 + R26$, the total resistance is R_{T20} , which equals $R25 + R26$, in parallel with $R27 + R28$. The *total* current with R_{T20} is $20I$.

F. Diode Gates (D5, D6)

The diode gates are silicon diodes D5 and D6. In the 1, 100 and 10K range, the positive current source puts out $2I$ and the negative current source sinks $-I$ current. The purpose of the gates is to either switch the output of the positive current source to the capacitors to charge them, or to shunt the current so that the negative current source can discharge the capacitors. The gates work as follows:

If the signal from the level detector is high-level TTL, $+5$ V, it reverse-biases diode D6 and cuts it off. Diode D5 now becomes forward-biased and all the current ($2I$) flows through D5. Since the negative current source can only sink $-I$ current, a net positive current, I , is seen by the capacitors and they are linearly charged to produce a positive ramp.

If the signal from the level detector is low-level TTL, 0 V, it forward-biases diode D6 and the level detector sinks all the current ($2I$), from the positive current source. Diode D5 now becomes reverse-biased and no current

flows thru it. The capacitors now see only the negative current source with -1 current and are linearly discharged to produce a negative ramp. In the 10, 1K, and 100K ranges the gates work exactly the same except that the currents are now 10 times greater.

G. C_T (C15, 16, 17, 18)

The timing capacitors C_T are chosen for such highly desirable qualities as:

Low dissipation factor.

Low temperature coefficient.

3. Long-term capacitance stability.

H. Triangle Buffer (Q7, Q8)

The triangle buffer has a very high impedance to minimize leakage currents and prevent loading of the timing capacitors. Q7 is a dual FET; one half is the high impedance buffer to the capacitors while the other half provides temperature compensation to the first half. Q8 is an emitter follower and is used to provide the necessary current to drive the level detector, sine shaper, etc. The three silicon diodes along with the base-emitter junction of Q8 shifts the triangle waveform seen at the emitter of Q8 up to four diode drops (about 2.6V) so that the diode dates can switch properly with a TTL level signal from the level detector.

Dual Level Detector & Flip-Flop (IC5)

The level detector senses the level of the ramp input (either positive or negative) and switches output states when the input reaches any one of two voltage limit references. The device (75107) has a dual differential input comparator stage and a dual three-input nand gate output stage connected as an R-S flip-flop. The input limit voltage references are set by two voltage dividers on the tracking +15 V and -15 V supplies. Resistors R32 and R33 set +1.25 V for the minus input of one comparator. Resistors R34 and R35 set -1.25 V for the plus input of the other comparator. C22 couples a small positive feedback from one output of the line receiver (pins 5 & 9) to the inputs (pins 2 & 12) to speed up the switching.

J. TTL Buffer (IC6B, IC6C)

IC6B and 6C are half of a quad nand gate package. They are connected in parallel and provide a fan-out of 20 for the TTL square wave. This avoids any loading on the level detector.

K. Square Wave Level Shifter (IC6A, IC6D)

The square wave level shifter shifts the DC level of the TTL output of the level detector so that it is approximately symmetrical about zero. IC 6A and 6D are connected in parallel. One set of inputs (pins 2 and 12) are switched so that the level shifter operates only when the square function button is pushed on. Trimpot R42 provides an amplitude adjustment for the square wave.

L. Sine Wave Shaper (IC7)

The sine wave shaper takes a triangle wave input and non-linearly shapes it to produce a sine wave. The shaper utilizes the non-linear relationship of a differential pair of transistors. The output is taken from one collector of the pair and buffered and level-shifted by the two other transistors in the package IC7. Trimpot R52 adjusts the amplitude of the sine wave and R59 adjusts its DC level at the output. Trimpots R50 and R55 are adjusted to provide the lowest distortion of the sine wave.

M. Output Amplifier (Q9, 10, 11, 12, 13)

The Output Amplifier consists of a differential input stage (Q9 and Q10) followed by a common emitter transistor, Q11. The output from Q11 is applied to a push-pull output stage (Q12 and Q13). Feedback is applied from the output to the base of Q10 by R70 and R69. The closed loop gain is approximately 10. DC offset is obtained by applying the offset voltage to the base of Q10 also.

N. Power Supply (IC1, IC2, IC3B, IC3C, Q1, Q2, 01, 2, 3, 4)

Power transformer T1, bridge diodes D1, 2, 3, 4 and filter capacitors C1 and C3 generate +22 V and -22 V unregulated. The +22 V is applied to IC1, a 78L15A voltage regulator, which generates the +15 V supply. The +22 V is also applied through R5 to IC2, a 78L05A regulator, which generates the +5 V. IC3C and Q1 comprise a -15 V regulator which is referenced to the +15 V via R1 and R2. In a similar manner, IC3B and Q2 comprise a -5 V regulator which is referenced to the +5 V supply via R7 and R8.

MAINTENANCE AND CALIBRATION

WARNING

The following instructions are for use by qualified personnel only. To avoid electric shock, do not perform servicing other than contained in the operating instructions unless you are qualified to do so.

2. A shock hazard is present when the case is removed once the line cord is plugged into an AC outlet. Avoid touching the fuse or bottom of the circuit board in the area of the fuse or power transformer. The fuse has 120 VAC (240 VAC on export models) on it even when the POWER switch is off.

Your **B & K-PRECISION** Model 3010 Function Generator was carefully checked and calibrated at the factory prior to shipment. Calibration of this instrument should not be attempted unless you are experienced and qualified in the use of precision laboratory equipment. Should any difficulty occur during repair or calibration, refer to the warranty service instructions at the rear of this manual for information or technical assistance.

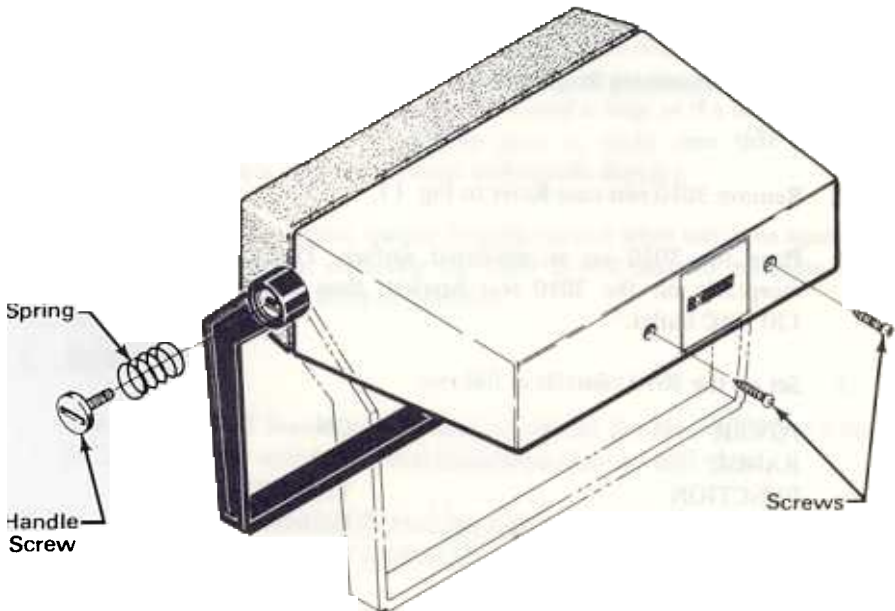

Fig. 17. Removal of rear case.

REMOVAL OF REAR CASE

To remove the rear case from the generator, proceed as follows:

Use a coin (a quarter works best) to remove the two screws that hold the handle to the case. Use caution to avoid losing the springs beneath the screws that hold the handle on the case. Remove the handle. The handle may be reversed if the user desires; refer to Fig. 17.

2. Remove the two Phillips head screws from the rear case.
3. Slide the rear case from the generator.
4. To re-install the rear case on the generator, follow the above procedure in reverse. When re-installing the rear case, be sure the printed circuit board properly engages the slots inside the case.

CALIBRATION PROCEDURE

A. Equipment Required:

Tektronix Model 465 Oscilloscope.

2. Hewlett-Packard Model 333A Distortion Analyzer.
3. B & K-PRECISION Model 1820 Universal Frequency Counter.
4. 600Ω Terminating Resistor.

B. Procedure:

Remove 3010 rear case Refer to Fig. 17.

2. Place the 3010 on an insulated surface. Plug the line cord into the receptacle on the 3010 rear bracket, then plug the other end into a 120 VAC outlet.
3. Set up the 3010 controls as follows:

POWER	ON
RANGE	100
FUNCTION	TRIANGLE
DC OFFSET	Centered
AMPLITUDE	Fully Counterclockwise
FREQUENCY	10

Refer to Fig. 18 for trimpot location and Table for trimpot function.

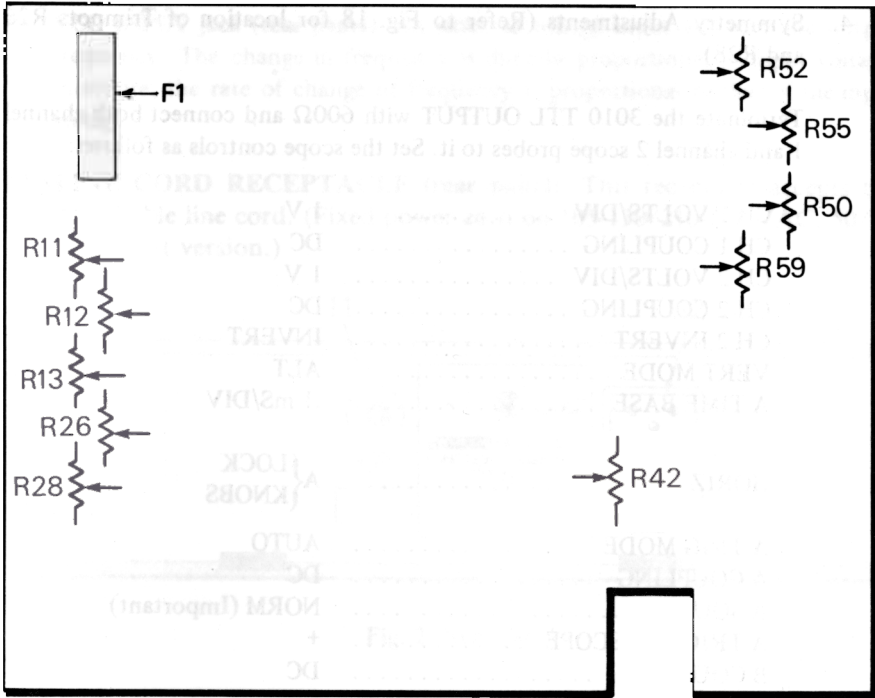

Fig. 18. Trimpot location.

Trimpot No.	Function
R26	1 KHz Symmetry
R28	10 KHz Symmetry
R42	Square Wave Amplitude
R50	Sine Distortion 1
R55	Sine Distortion 2
R52	Sine Wave Amplitude
R59	Sine Wave DC Level
R13	10 K Range Frequency
R12	1 K & 100 Range Frequency
R11	10 & 1 Range Frequency

Table I. Trimpot Function

4. Symmetry Adjustments (Refer to Fig. 18 for location of Trimpots R26 and R28).

Terminate the 3010 TTL OUTPUT with 600Ω and connect both channel 1 and channel 2 scope probes to it. Set the scope controls as follows:

CH 1 VOLTS/DIV	1 V
CH 1 COUPLING	DC
CH 2 VOLTS/DIV	1 V
CH 2 COUPLING	DC
CH 2 INVERT ..	INVERT
VERT MODE ...	ALT
A TIME BASE ..	.1 mS/DIV
HORIZ DISPLAY	A { LOCK KNOBS
A TRIG MODE ...	AUTO
A COUPLING	DC
A SOURCE	NORM (Important)
A TRIGGER SCOPE	+
B COUPLING	DC
B SOURCE	STARTS AFTER DELAY

Adjust CH 1 and CH 2 position controls to center each trace and adjust A TRIGGER level for a stable trigger. The display should appear to be two squares in phase but since CH 2 is inverted and NORM source triggering is used, what appears to be falling edge of CH 2 is actually the leading edge of the TTL OUTPUT.

Change HORIZ DISPLAY to A INTEN.

Use the B TIME/DIV KNOB (pull to unlock) and the DELAY TIME POSITION CONTROL to center the intensified trace to the trailing edges of the square waves. Continue until the B TIME/DIV setting is $1\ \mu\text{S}/\text{DIV}$.

Now change HORIZ DISPLAY TO B DLY'D and the display should show an expanded view of the falling edges of the square waves.

Adjust Trimpot R26 so that the edges coincide.

Change the 3010 RANGE setting to 1 K and repeat the above procedure but change A TIME/DIV to $10\ \mu\text{S}/\text{DIV}$ and B TIME/DIV to $.1\ \mu\text{S}/\text{DIV}$ and adjust Trimpot R28 so that the trailing edges of the two square waves coincide.

Amplitude Correlation and Sine Distortion Adjustments. Terminate the 3010 600Ω OUTPUT with 600Ω and connect channel 1 scope probe to it. Change the scope controls to the new settings as follows:

CH 1 VOLTS/DIV .	2V
CH 1 COUPLING ..	GND
VERT MODE	CH 1
TIME BASE	1 mS/DIV
HORIZ DISPLAY .	A LOCK KNOBS

Adjust CH 1 POSITION control to center the trace on the scope grid. Flip CH 1 COUPLING to AC. Push in the 3010 100 RANGE button and rotate the 3010 AMPLITUDE knob clockwise until the triangle wave just touches the 0 and 100 dotted lines on the scope grid. Flip CH 1 COUPLING to DC. Rotate the 3010 DC OFFSET knob until the triangle wave just touches the 0 to 100 dotted lines on the scope grid.

Push in the 3010 SQUARE FUNCTION button. Flip CH 1 COUPLING to AC. Adjust Trimpot R42 until the square wave just touches the 0 and 100 dotted lines on the scope grid.

6. Push in the 3010 SINE FUNCTION button. Connect the distortion analyzer to the 3010 600Ω OUTPUT. Manipulate the distortion analyzer for a minimum distortion reading. Adjust Trimpot R50 first, then Trimpot R55, for a minimum distortion reading. Readjust both Trimpots R50 and R55 for a minimum distortion reading (must be less than or equal to 0.5%). Disconnect the distortion analyzer.

Adjust Trimpot R52 until the sine wave just touches the 0 and 100 dotted lines on the scope grid. Flip CH 1 COUPLING to DC. Adjust Trimpot R59 until the sine wave just touches the 0 and 100 dotted lines on the scope grid.

7. Frequency Adjustments.

Connect the counter to the 3010 600Ω OUTPUT. Set the counter to PERIOD FUNCTION. Push in the 3010 10 K RANGE button and be sure that the 3010 FREQUENCY dial is set to 10. Adjust Trimpot R13 for a counter reading of 10.000 μS. OK if counter reading is between 9.980 μS and 10.020 μS:

Push in the 3010 100 RANGE button. Adjust Trimpot R12 for a counter reading of 1000.00 μS. OK if counter reading is between 998.000 μS and 1002.00 μS.

Push in the 3010 10 RANGE button. Adjust Trimpot R11 for a counter reading of 10.0000 mS. OK if counter reading is between 9980.00 μ S and 10.0200 mS.

8. Disconnect the scope probe and counter from the 3010 600 Ω OUTPUT. Carefully re-install the rear case (refer to Fig. 17)

LINE VOLTAGE CONVERSION

The 105-130 volt, 60 Hz power transformer (065-137-9-001) used in the standard 3010 is replaced by a 105-130/210-260 volt, 50/60 Hz power transformer (065-137-9-002) in the export version. The line cord in the export version uses standard DIN color codes. The power transformer is normally prewired to match the power source used in the country of original sale. The instrument may be easily converted to the alternate line voltage. To convert from 210-260 volt operation to 105-130 volt operation, or vice versa, use the following procedure:

Remove case (Fig. 17).

2. Rewire power transformer for desired line voltage (Fig. 19).
3. Change fuse F1 (see Fig. 18 for location). Use $\frac{1}{8}$ A, 3AG slow blow for 105-130 volt operation, or $\frac{1}{6}$ A, 3AG slow blow for 210-260 volt operation.
4. Change line voltage label.

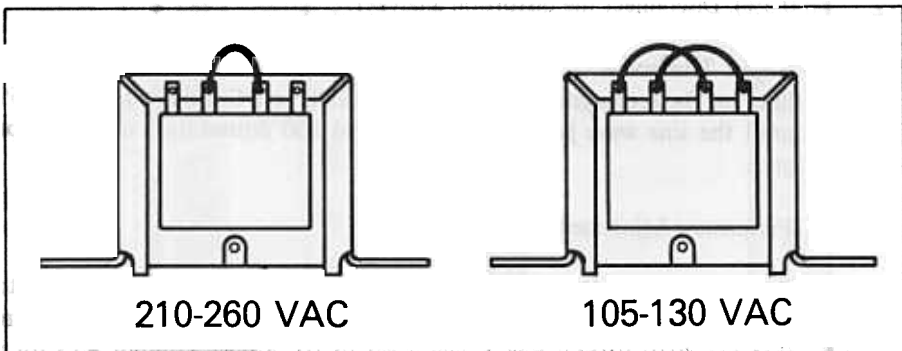

Fig. 19. Transformer wiring, export version.

WARRANTY SERVICE INSTRUCTIONS

1. Refer to the **MAINTENANCE** section of your B & K-Precision instruction manual for adjustments that may be applicable.
2. If the above-mentioned procedures do not correct the problem you are experiencing with your unit, pack it securely (preferably in the original carton or double-packed). Enclose a letter describing the problem and include your name and address. Deliver to, or ship **PREPAID** (UPS preferred) to the nearest B & K-Precision authorized service agency (see list enclosed with unit).

If your list of authorized B & K-Precision service agencies has been misplaced, contact your local distributor for the name of your nearest service agency, or write to:

Service Department

**B & K-Precision Product Group
DYNASCAN CORPORATION
2815 West Irving Park Road
Chicago, Illinois 60618**

LIMITED ONE-YEAR WARRANTY

DYNASCAN CORPORATION warrants to the original purchaser that its B & K-PRECISION product, and the component parts thereof, will be free from defects in workmanship and materials for a period of one year from the date of purchase.

DYNASCAN will, without charge, repair or replace, at its option, defective product or component parts upon delivery to an authorized B & K-PRECISION service contractor or the factory service department, accompanied by proof of the date of purchase in the form of a sales receipt.

To obtain warranty coverage, this product must be registered by completing and mailing the enclosed warranty registration card to DYNASCAN, B & K-PRECISION, 6460 West Cortland Street, Chicago, Illinois 60635 within fifteen (15) days from the date of purchase.

Exclusions: This warranty does not apply in the event of misuse or abuse of the product or as a result of unauthorized alterations or repairs. It is void if the serial number is altered, defaced or removed.

DYNASCAN shall not be liable for any consequential damages, including without limitation damages resulting from loss of use. Some states do not allow limitation of incidental or consequential damages, so the above limitation or exclusion may not apply to you.

This warranty gives you specific rights and you may also have other rights which vary from state to state.

For your convenience we suggest you contact your B & K-PRECISION distributor, who may be authorized to make repairs or can refer you to the nearest service contractor. If warranty service cannot be obtained locally, please send the unit to B & K-PRECISION Service Department, 2815 West Irving Park Road, Chicago, Illinois 60618, properly packaged to avoid damage in shipment.

B+K PRECISION **DYNASCAN**
CORPORATION

6460 W. Cortland Street
Chicago, Illinois 60635

© 1981 • DYNASCAN CORP.

480-225-9-001 C

PRINTED IN U.S.A.

